

BRUSHLESS DC FAN
120x120x38 mm

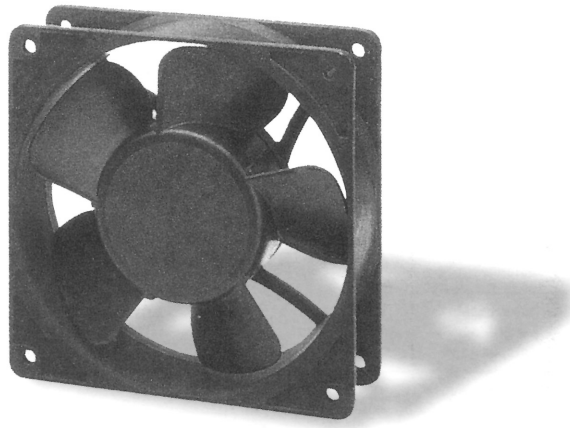

Model	Part No. Terminal Leadwire	Bearing System	Rated Voltage	Current	Input Power	Air Flow	Static Pressure	Speed	Noise Level	Weight
			V	A	W	CFM	mm-H ₂ O	rpm	dB-A	g
SJ1238HD1	1238HD1S(B)PL	Sleeve/Ball	12	0.50	6.00	104.8	6.74	2800	42.8	297
SJ1238MD1	1238MD1S(B)PL	Sleeve/Ball	12	0.35	4.20	94.0	6.11	2540	41.0	297
SJ1238LD1	1238LD1S(B)PL	Sleeve/Ball	12	0.24	2.88	72.38	3.37	1950	32.9	297
SJ1238HD2	1238HD2S(B)PL	Sleeve/Ball	24	0.32	7.68	104.8	6.74	2800	42.8	297
SJ1238MD2	1238MD2S(B)PL	Sleeve/Ball	24	0.23	5.52	94.0	6.11	2540	41.0	297
SJ1238LD2	1238LD2S(B)PL	Sleeve/Ball	24	0.14	3.36	72.3	3.37	1950	32.9	297

Dimensions (mm)

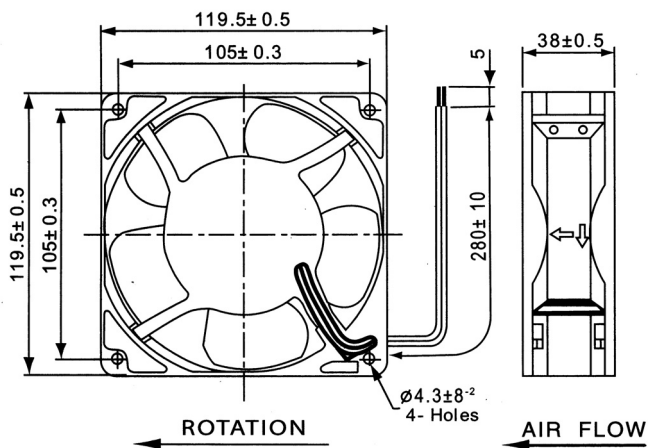

Performance Curve

