

**BRUSHLESS DC FAN**  
50x50x10 mm

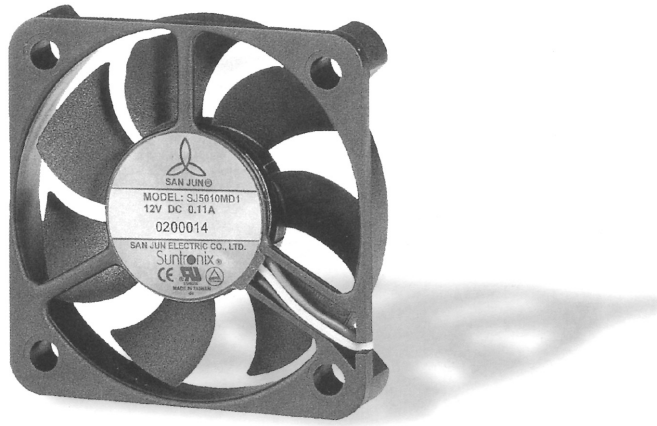

Model	Part No. Terminal Leadwire	Bearing System	Rated Voltage	Current	Input Power	Air Flow	Static Pressure	Speed	Noise Level	Weight
			V	A	W	CFM	mm-H <sub>2</sub> O	rpm	dB-A	g
SJ5010HD5	5010HD5S(B)PL	Sleeve/Ball	5	0.24	1.20	9.50	2.13	4800	30.0	22
SJ5010MD5	5010MD5S(B)PL	Sleeve/Ball	5	0.18	0.90	8.38	1.73	4300	27.0	22
SJ5010LD5	5010LD5S(B)PL	Sleeve/Ball	5	0.14	0.70	7.20	1.65	3800	24.0	22
SJ5010HD1	5010HD1S(B)PL	Sleeve/Ball	12	0.18	2.16	9.50	2.13	4800	30.0	22
SJ5010MD1	5010MD1S(B)PL	Sleeve/Ball	12	0.11	1.32	8.38	1.73	4300	27.0	22
SJ5010LD1	5010LD1S(B)PL	Sleeve/Ball	12	0.09	1.08	7.20	1.65	3800	24.0	22

**Dimensions (mm)**

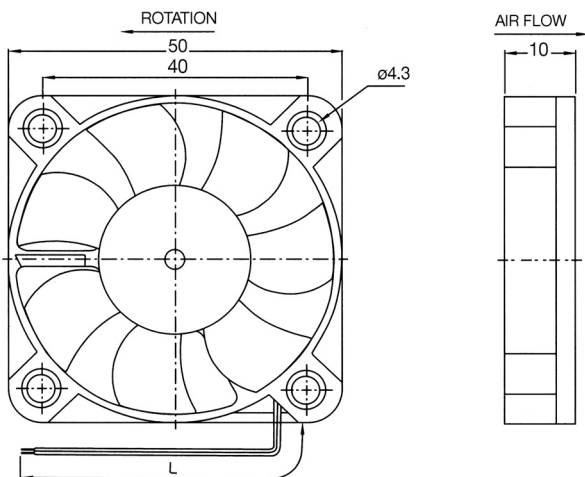

**Performance Curve**

